

ER-TFT101B4-1-6104



EastRising Technology Co., Limited

Attention:

- A. Some specifications of IC are not listed in this datasheet. Please refer to the IC datasheet for more details.
- B. The related documents for interfacing, demo code, IC datasheet are all available, please download from our web.
- C. Please pay more attention to "INSPECTION CRITERIA" in this datasheet. We assume you already agree with these criterion when you place an order with us. No more recommendations.

REV	Description	Release Date
1.0	Preliminary Release	Nov-01-2024

CONTENTS

1. ORDER INFORMATION	04
1.1 Order Number	04
1.2 Image	04
2. SPECIFICATION	06
2.1 Display Specification	06
2.2 MCU/FLASH Specification	06
2.3 Mechanical Specification	06
2.4 Electrical Specification	06
2.5 Optical Specification	06
3. OUTLINE DRAWING	07
3.1 ER-TFT101B4-1-6104 with No Touch Panel	07
3.2 ER-TFT101B4-1-6104 with Resistive Touch Panel	08
3.3 ER-TFT101B4-1-6104 with Capacitive Touch Panel	09
4. ELECTRICAL SPEC	10
4.1 CON2&CON4 (Uart) Pin Configuration	10
4.2 Type-C USB Interface	10
4.3 JP2 (Encoder) Pin Configuration	10
4.4 Absolute Maximum Ratings	11
4.5 Electrical Characteristics	11
5. INSPECTION CRITERIA	12
5.1 Acceptable Quality Level	12
5.2 Definition of Lot	12
5.3 Condition of Cosmetic Inspection	12
5.4 Module Cosmetic Criteria	13
5.5 Screen Cosmetic Criteria (Non-Operating)	15
5.6 Screen Cosmetic Criteria (Operating)	16
6. PRECAUTIONS FOR USING	18
6.1 Handling Precautions	18
6.2 Power Supply Precautions	18
6.3 Operating Precautions	19
6.4 Mechanical/Environmental Precautions	19
6.5 Storage Precautions	19
6.6 Others	19

7.USING LCD MODULES	20
7.1 Liquid Crystal Display Modules	20
7.2 Installing LCD Modules	20
7.3 Precaution for Handling LCD Modules	20
7.4 Electro-Static Discharge Control-	21
7.5 Precaution for Soldering to EastRising LCM-	21
7.6 Precaution for Operation	21
7.7 Limited Warranty	22
7.8 Return Policy	22
 8. IMAGE STICKING	 23
8.1 What is Image Sticking?	23
8.2 What causes Image Sticking?	23
8.3 How to Avoid Image Sticking?	24
8.4 How to Fix the Image Sticking?	24
8.5 Is Image Sticking Covered by EastRising RMA Warranty?	24

1. ORDERING INFORMATION

1.1 Order Number

Order Number	Description
ER-TFT101B4-1-6104	10.1" UART Display with no Touch Panel.
ER-TP101-1	10.1" Resistive Touch Panel.
ER-TPC101-1	10.1" Capacitive Touch Panel with Controller.

1.2 Image



← ER-TFT101B4-1-6104 with No Touch Panel



ER-TFT101B4-1-6104 with Resistive Touch Panel →



← ER-TFT101B4-1-6104 with Capacitive Touch Panel

UART Board Image

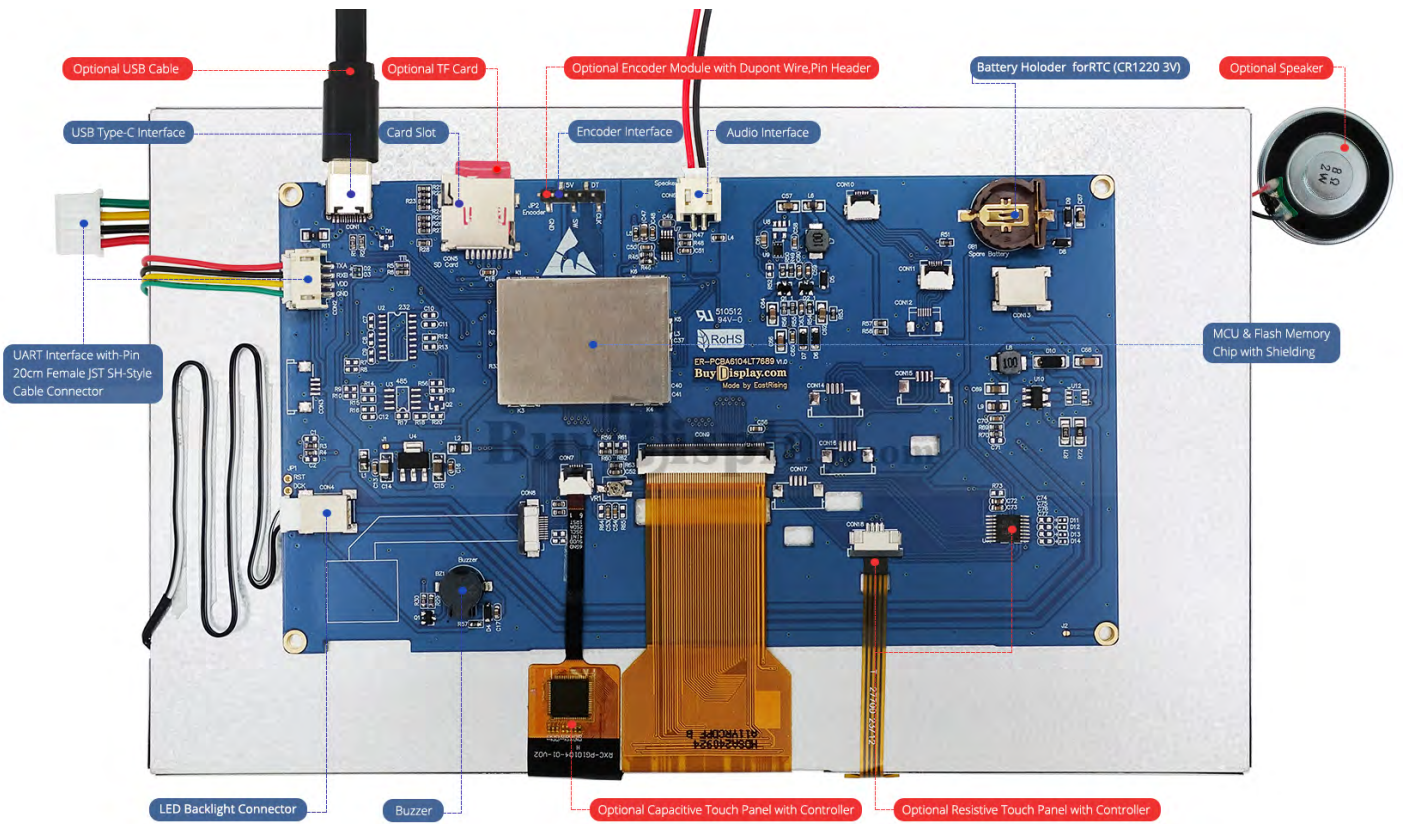

Debug Board Image

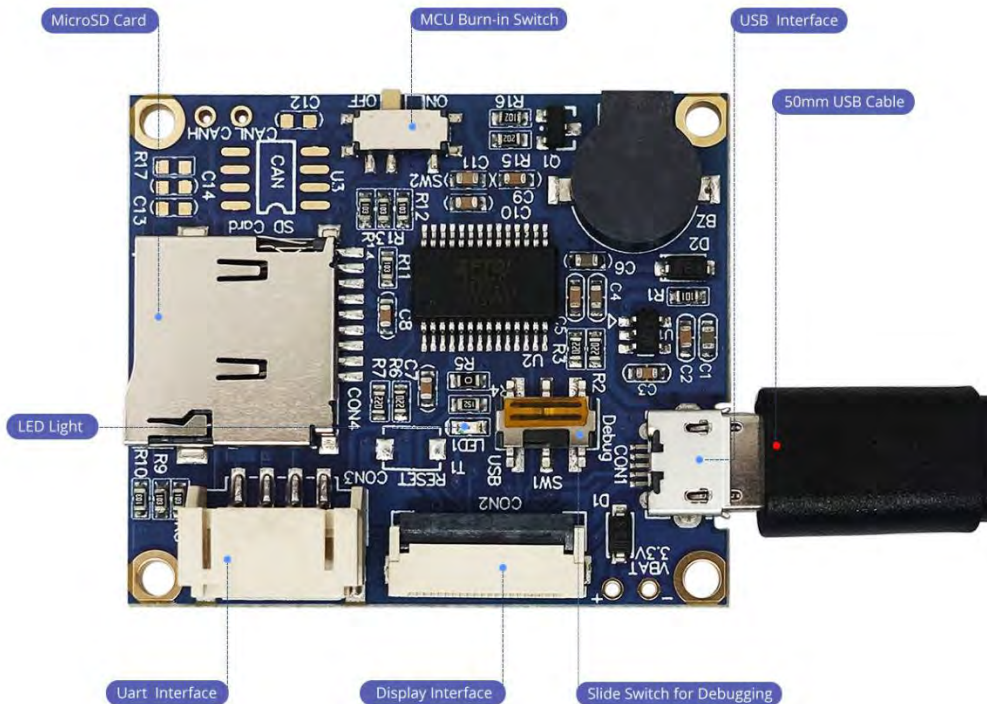

2. SPECIFICATION

2.1 Display Specification

Item	Standard Value	Unit
Display Format	1024x600 / 600x1024	Pixels
Display Connector	Female JST SH-Style Cable	--
Operating Temperature	-20 ~ +70	°C
Storage Temperature	-30 ~ +80	°C
Touch Panel Optional	Yes	--

2.2 MCU/FLASH Specification

Item	Standard Value	Unit
MCU Number	7689	--
MCU Max. Speed	150	MHz
MCU SRAM	256	KB
External SPI Flash	NAND/1G	bit

2.3 Mechanical Specification

Item	Standard Value	Unit
Diagonal Size	10.1	Inch
Outline Dimension	235.00(W)x143.00(H)	mm
Visual Area	226.40(W)x128.70(H)	mm
Active Area	222.72(W)x125.28(H)	mm
Dot Pitch	0.217x0.208	mm

2.4 Electrical Specification

Item	Standard Value	Unit
IC Package	SMT	--
Interface	Serial Uart Interface	--
Response Time (Typ)	25	MS

2.5 Optical Specification

Item	Standard Value	Unit
LCD Type	IPS	--
Viewing Angle Range	Left:80 , Right:80 , Up:80 , Down:80	Deg
Colors	65k	--
Contrast Ratio (Typ)	800:1	--
Brightness (Typ)	500	cd/m2

3. OUTLINE DRAWING

3.1 ER-TFT101B4-1-6104 with no Touch Panel

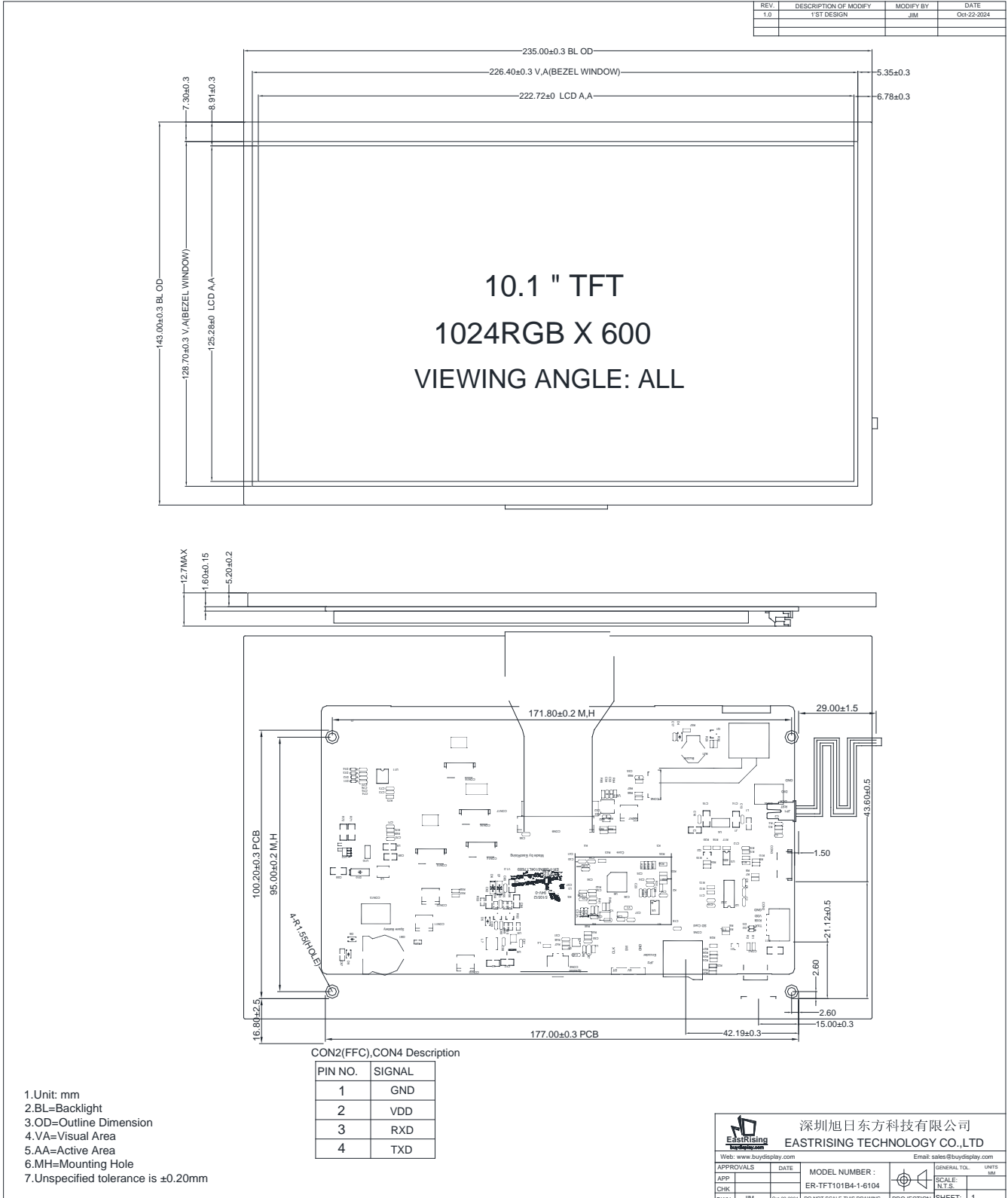

3.2 ER-TFT101B4-1-6104 with Resistive Touch Panel

REV.	DESCRIPTION OF MODIFY	MODIFY BY	DATE
1.0	1ST DESIGN	JIM	Oct-22-2024

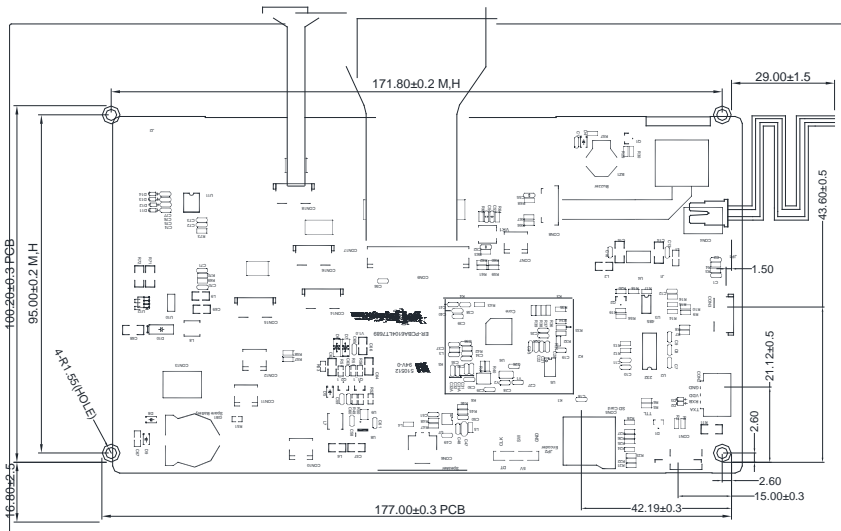
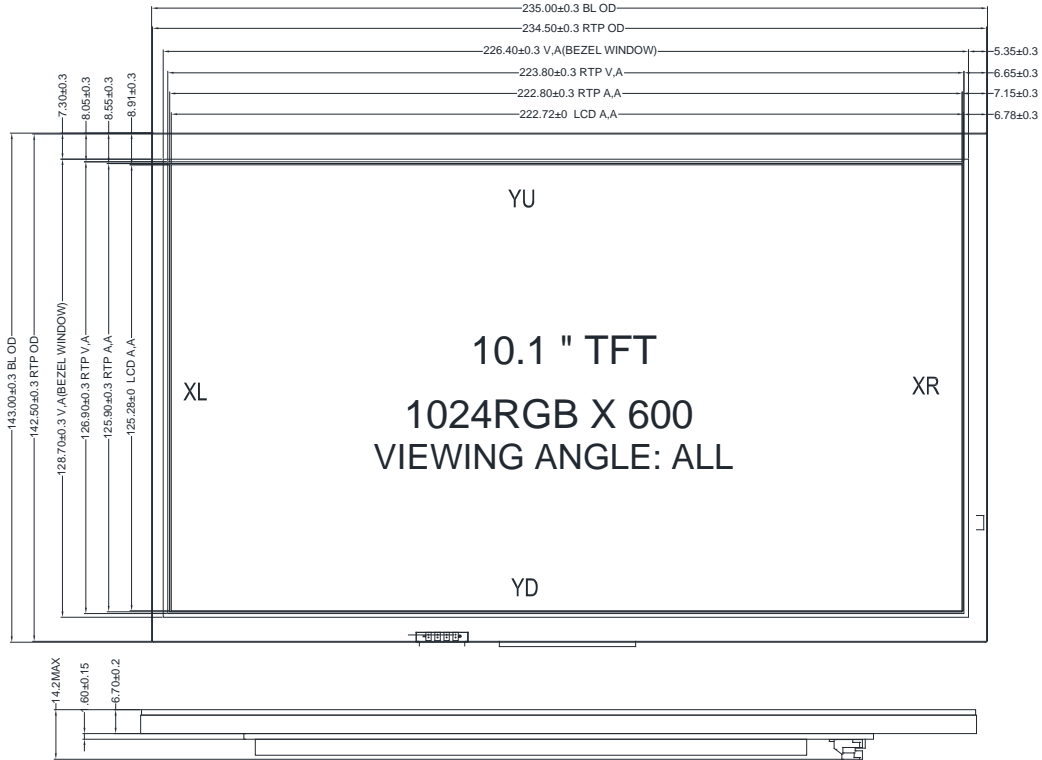

1. Unit: mm
2. BL=Backlight
3. OD=Outline Dimension
4. VA=Visual Area
5. AA=Active Area
6. RTP= Resistive Touch Panel
7. MH=Mounting Hole
8. Unspecified tolerance is ±0.20mm

CON2(FFC),CON4 Description

PIN NO.	SIGNAL
1	GND
2	VDD
3	RXD
4	TXD



深圳旭日东方科技有限公司
EASTRISING TECHNOLOGY CO.,LTD

Web: www.buydisplay.com
Email: sales@buydisplay.com

APPROVALS: _____ DATE: _____
 MODEL NUMBER: ER-TFT101B4-1-6104
 APP: _____
 CHK: _____
 DWN: JIM Oct-22-2024



SCALE: N.T.S.
 SHEET: 1

GENERAL TOL. UNITS: MM
 PROJECTION: SHEET: 1

3.3 ER-TFT101B4-1-6104 with Capacitive Touch Panel

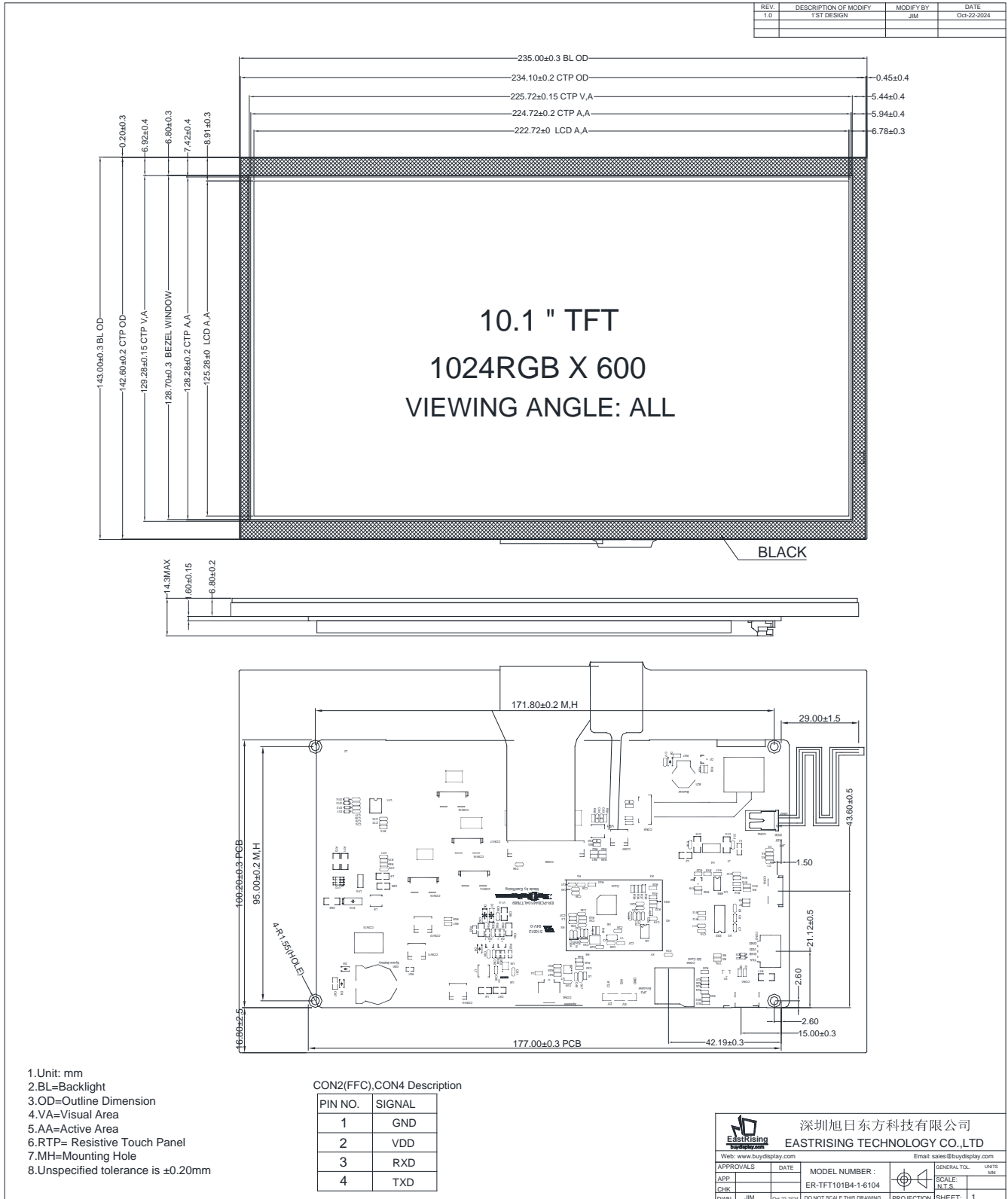

4. ELECTRICAL SPEC

4.1 CON2&CON4 (Uart) Pin Configuration

Pin No	Pin Name	Descriptions
1	VDD	Power Input
2	GND	Ground
3	RXD	Serial Uart Interface – Data Input This is the data input of the Serial Uart communication interface, which is used to receive the instruction signal from the TX at the main system board.
4	TXD	Serial Uart Interface – Data Output This is the data output of the Serial Uart communication interface, which is used to transmit the instruction signal to the RX at the main system board.

4.2 Type-C USB Interface

Pin No	Pin Name	Description
A1,A12, B1,B12	GND	Ground
A4,A9, B4,B9	VDD	+5V
A6,B6	D+	DP(Not used)
A7,B7	D-	DM(Not used)

4.3 JP2 (Enocder) Pin Configuratio

Pin No	Pin Name	Descriptions
1	GND	Ground
2	VDD	Power Input
3	SW	Key
4	DT	Signal A
5	CLK	Signal B

Optional, not installed by default

4.4 Absolute Maximum Ratings

Item	Symbol	Min	Typ	Max	Unit
Power Supply Voltage	VCI	-0.3	-	+5.5	V
Operating Temperature	TOP	-20	-	+70	°C
Storage Temperature	TST	-30	-	+80	°C
Humidity	RH	-	-	90%(Max60°C)	RH

4.5 Electrical Characteristics

Item	Symbol	Min	Typ	Max	Unit
Power Supply Voltage	VDD	4.8	5.0	5.5	V
Input Voltage'H'Level (RXD)	VIH	2.0	3.3	5.0	V
Input Voltage'L'Level (RXD)	VIL	VSS	-	0.8	V
Output Voltage'H'level(TXD)	VOH	2.4	-	3.3	V
Output Voltage'L'level(TXD)	VCL	VSS	-	0.4	V
Uart baud rate	--	9600	115200	1382400	bps
Flash	--	--		1G	Mbit
Module Current	IDD	--	650	830	mA

5. INSPECTION CRITERIA

5.1 Acceptable Quality Level

Each lot should satisfy the quality level defined as follows

Partition	AQL	Definition
A. Major	0.4%	Functional defective as product
B. Minor	1.5%	Satisfy all functions as product but not satisfy cosmetic standard

5.2 Definition of Lot

One lot means the delivery quantity to customer at one time.

5.3 Condition of Cosmetic Inspection

◆ INSPECTION AND TEST

- FUNCTION TEST
- APPEARANCE INSPECTION
- PACKING SPECIFICATION

◆ INSPECTION CONDITION

- Put under the lamp (20W) at a distance 100mm from
- Tilt upright 45 degree by the front (back) to inspect LCD appearance.

◆ AQL INSPECTION LEVEL

- SAMPLING METHOD: MIL-STD-105D
- SAMPLING PLAN: SINGLE
- MAJOR DEFECT: 0.4% (MAJOR)
- MINOR DEFECT: 1.5% (MINOR)
- GENERAL LEVEL: II/NORMAL

5.4 Module Cosmetic Criteria

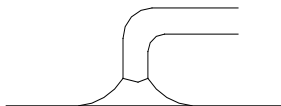
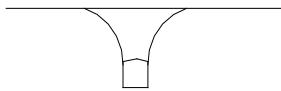
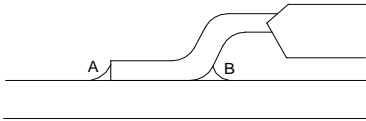
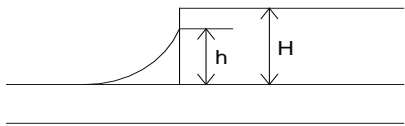
No.	Item	Judgment Criterion	Partition
1	Difference in Spec.	None allowed	Major
2	Pattern Peeling	No substrate pattern peeling and floating	Major
3	Soldering Defects	No soldering missing	Major
		No soldering bridge	Major
		No cold soldering	Minor
4	Resist Flaw on Substrate	Invisible copper foil(ϕ 0.5mm or more)on substrate pattern	Minor
5	Accretion of Metallic Foreign Matter	No soldering dust	Minor
		No accretion of metallic foreign matters(Not exceed ϕ 0.2mm)	
6	Stain	No stain to spoil cosmetic badly	Minor
7	Plate Discoloring	No plate fading, rusting and discoloring	Minor
8	1.Lead Parts	<p>a. Soldering side of PCB Solder to form a 'Filet' all around t Solder should not hide the lead form</p>  <p>b.Components side (In case of 'Through Hole PCB') Solder to reach the Components side of PCB</p> 	Minor
	2.Flat Packages	<p>Either 'toe' (A) or 'heel' (B) of the lead to be covered by Filet'</p>  <p>Lead form to be assume over solder.</p>	Minor
	3.Chips	<p>$(3/2) H \geq h \geq (1/2)H$</p> 	Minor

9	Backlight Defects	<ol style="list-style-type: none"> 1.Light fails or flickers.(Major) 2. Color and luminance do not correspond to specifications. (Major) 3.Exceeds standards for display' s blemishes, foreign matter, dark lines or scratches.(Minor) 	<p>See list ←</p>
10	PCB Defects	<ol style="list-style-type: none"> Oxidation or contamination on connectors.* 2. Wrong parts, missing parts, or parts not in specification.* 3.Jumpers set incorrectly.(Minor) 4.Solder(if any)on bezel, LED pad, zebra pad, or screw hole pad is not smooth.(Minor) <p>*Minor if display functions correctly. Major if the display fails.</p>	<p>See list ←</p>
11	Soldering Defects	<ol style="list-style-type: none"> 1. Unmelted solder paste. 2. Cold solder joints, missing solder connections, or oxidation.* 3. Solder bridges causing short circuits.* 4. Residue or solder balls. 5. Solder flux is black or brown. <p>*Minor if display functions correctly. Major if the display fails.</p>	<p>Minor</p>

5.5 Screen Cosmetic Criteria (Non-Operating)

No.	Defect	Judgment Criterion	Partition	
1	Spots	In accordance with Screen Cosmetic Criteria (Operating) No.1.	Minor	
2	Lines	In accordance with Screen Cosmetic Criteria (Operation) No.2.	Minor	
3	Bubbles in Polarizer		Minor	
		Size: d mm		Acceptable Qty in active area
		d \leq 0.3		Disregard
		0.3 < d \leq 1.0		3
1.0 < d \leq 1.5	1			
1.5 < d	0			
4	Scratch	In accordance with spots and lines operating cosmetic criteria, When the light reflects on the panel surface, the scratches are not to be remarkable.	Minor	
5	Allowable density	Above defects should be separated more than 30mm each other.	Minor	
6	Coloration	Not to be noticeable coloration in the viewing area of the LCD panels. Back-lit type should be judged with back-lit on state only.	Minor	
7	Contamination	Not to be noticeable.	Minor	

5.6 Screen Cosmetic Criteria (Operating)

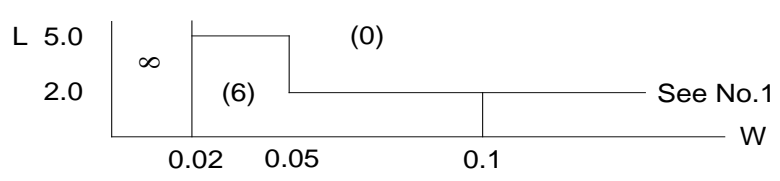
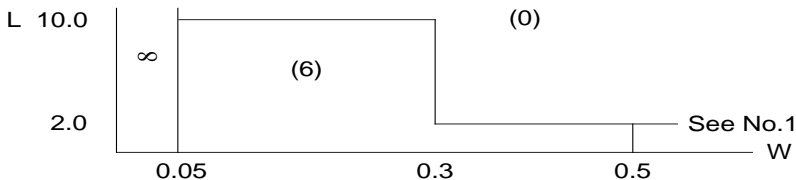
No.	Defect	Judgment Criterion	Partition	
1	Spots	A) Clear	Minor	
		Size:d mm		Acceptable Qty in active area
		$d \leq 0.1$		Disregard
		$0.1 < d \leq 0.2$		6
		$0.2 < d \leq 0.3$		2
		$0.3 < d$		0
Note: Including pin holes and defective dots which must be within one pixel Size. Unclear				
		Size:d mm	Acceptable Qty in active area	
		$d \leq 0.2$	Disregard	
		$0.2 < d \leq 0.5$	6	
		$0.5 < d \leq 0.7$	2	
		$0.7 < d$	0	
2	Lines	A) Clear	Minor	
		 <p>Note: () – Acceptable Qty in active area L - Length (mm) W -Width(mm) ∞-Disregard</p>		
		B) Unclear		
				
<p>Clear' = The shade and size are not changed by Vo. Unclear' = The shade and size are changed by Vo.</p>				

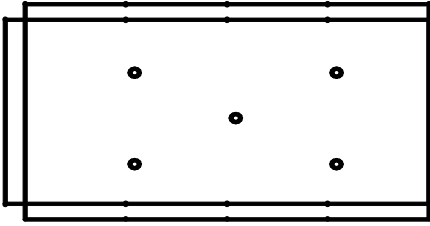
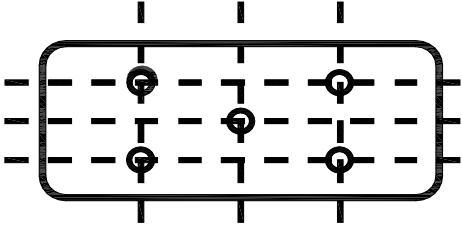
No.	Defect	Judgment Criterion	Partition
3	Rubbing line	Not to be noticeable.	Minor
4	Allowable density	Above defects should be separated more than 10mm each other.	Minor
5	Rainbow	Not to be noticeable.	Minor
6	Dot size	To be 95%~105%of the dot size (Typ.) in drawing. Partial defects of each dot (ex.pin-hole) should be treated as spot. (see Screen Cosmetic Criteria (Operating) No.1)	Minor
7	Brightness (only back-lit Module)	Brightness Uniformity must be $B_{MAX}/B_{MIN} \leq 2$ - BMAX : Max.value by measure in 5 points - BMIN : Min.value by measure in 5 points Divide active area into 4 vertically and horizontally. Measure 5 points shown in the following figure. 	Minor
8	Contrast Uniformity	Contrast Uniformity must be $B_{mAX}/B_{mIN} \leq 2$ Measure 5 points shown in the following figure. Dashed lines divide active area into 4 vertically and horizontally. Measuring points are located at the inter-sections of dashed line.  Note: BMAX – Max.value by measure in 5 points. BMIN – Min.value by measure in 5 points. O – Measuring points in $\phi 10\text{mm}$.	Minor

Note:
 (1) Size: $d = (\text{long length} + \text{short length}) / 2$
 (2) The limit samples for each item have priority.
 (3) Complexed defects are defined item by item, but if the number of defects is defined in above table, the total number should not exceed 10.

(4) In case of 'concentration' , even the spots or the lines of 'disregarded' size should not be allowed. Following three situations should be treated as 'concentration' .

-7 or over defects in circle of ϕ 5mm.

-10 or over defects in circle of ϕ 10mm

-20 or over defects in circle of ϕ 20mm

6. PRECAUTIONS FOR USING

6.1 Handling Precautions

- ◆ This device is susceptible to Electro-Static Discharge (ESD) damage. Observe Anti-Static precautions.
- ◆ EastRising display panel is made of glass. Do not subject it to a mechanical shock by dropping it or impact.
- ◆ If EastRising display panel is damaged and the liquid crystal substance leaks out, be sure not to get any in your mouth. If the substance contacts your skin or clothes, wash it off using soap and water.
- ◆ Do not apply excessive force to the EastRising display surface or the adjoining areas since this may cause the color tone to vary.
- ◆ The polarizer covering the EastRising display surface of the LCD module is soft and easily scratched. Handle this polarizer carefully.
- ◆ If EastRising display surface becomes contaminated, breathe on the surface and gently wipe it with a soft dry cloth. If it is heavily contaminated, moisten cloth with one of the following Isopropyl or alcohol.
- ◆ Solvents other than those above-mentioned may damage the polarizer. Especially, do not use the Water.
- ◆ Exercise care to minimize corrosion of the electrode. Corrosion of the electrodes is accelerated by water droplets, moisture condensation or a current flow in a high-humidity environment.
- ◆ Install the EastRising LCD Module by using the mounting holes. When mounting the LCD module make sure it is free of twisting, warping and distortion. In particular, do not forcibly pull or bend the cable or the backlight cable.
- ◆ Do not attempt to disassemble or process EastRising LCD module.
- ◆ NC terminal should be open. Do not connect anything.
- ◆ If the logic circuit power is off, do not apply the input signals.
- ◆ To prevent destruction of the elements by static electricity, be careful to maintain an optimum work environment.
 - Be sure to ground the body when handling EastRising LCD modules.
 - Tools required for assembling, such as soldering irons, must be properly grounded.
- To reduce the amount of static electricity generated, do not conduct assembling and other work under dry conditions.
- The LCD module is coated with a film to protect the display surface. Exercise care when peeling off this protective film since static electricity may be generated.

6.2 Power Supply Precautions

- ◆ Identify and, at all times, observe absolute maximum ratings for both logic and LC drivers. Note that there is some variance between models.
- ◆ Prevent the application of reverse polarity to VDD and VSS, however briefly.
- ◆ Use a clean power source free from transients. Power-up conditions are occasionally jolting and may exceed the maximum ratings of EastRising modules.
- ◆ The VDD power of EastRising module should also supply the power to all devices that may access the display. Don't allow the data bus to be driven when the logic supply to the module is turned off.

6.3 Operating Precautions

- ◆ DO NOT plug or unplug EastRising module when the system is powered up.
- ◆ Minimize the cable length between EastRising module and host MPU.
- ◆ For models with backlights, do not disable the backlight by interrupting the HV line. Unload inverters produce voltage extremes that may arc within a cable or at the display.
- ◆ Operate EastRising module within the limits of the modules temperature specifications.

6.4 Mechanical/Environmental Precautions

- ◆ Improper soldering is the major cause of module difficulty. Use of flux cleaner is not recommended as they may seep under the electrometric connection and cause display failure.
- ◆ Mount EastRising module so that it is free from torque and mechanical stress.
- ◆ Surface of the LCD panel should not be touched or scratched. The display front surface is an easily scratched, plastic polarizer. Avoid contact and clean only when necessary with soft, absorbent cotton dampened with petroleum benzene.
- ◆ Always employ anti-static procedure while handling EastRising module.
- ◆ Prevent moisture build-up upon the module and observe the environmental constraints for storage tem
- ◆ Do not store in direct sunlight
- ◆ If leakage of the liquid crystal material should occur, avoid contact with this material, particularly ingestion. If the body or clothing becomes contaminated by the liquid crystal material, wash thoroughly with water and soap.

6.5 Storage Precautions

When storing the LCD modules, avoid exposure to direct sunlight or to the light of fluorescent lamps.

Keep EastRising modules in bags (avoid high temperature / high humidity and low temperatures below 0 °C).

Whenever possible, EastRising LCD modules should be stored in the same conditions in which they were shipped from our company.

6.6 Others

Liquid crystals solidify under low temperature (below the storage temperature range) leading to defective orientation or the generation of air bubbles (black or white). Air bubbles may also be generated if the module is subject to a low temperature. If EastRising LCD modules have been operating for a long time showing the same display patterns, the display patterns may remain on the screen as ghost images and a slight contrast irregularity may also appear. A normal operating status can be regained by suspending use for some time. It should be noted that this phenomenon does not adversely affect performance reliability.

To minimize the performance degradation of the LCD modules resulting from destruction caused by static electricity etc., exercise care to avoid holding the following sections when handling the modules.

- Exposed area of the printed circuit board.
- Terminal electrode sections.

7. USING LCD MODULES

7.1 Liquid Crystal Display Modules

EastRising LCD is composed of glass and polarizer. Pay attention to the following items when handling.

- ◆ Please keep the temperature within specified range for use and storage. Polarization degradation, bubble generation or polarizer peel-off may occur with high temperature and high humidity.
- ◆ Do not touch, push or rub the exposed polarizers with anything harder than an HB pencil lead (glass, tweezers, etc.).
- ◆ N-hexane is recommended for cleaning the adhesives used to attach front/rear polarizers and reflectors made of organic substances which will be damaged by chemicals such as acetone, toluene, ethanol and isopropyl alcohol.
- ◆ When EastRising display surface becomes dusty, wipe gently with absorbent cotton or other soft material like chamois soaked in petroleum benzin. Do not scrub hard to avoid damaging the display surface.
- ◆ Wipe off saliva or water drops immediately, contact with water over a long period of time may cause deformation or color fading.
- ◆ Avoid contacting oil and fats.
- ◆ Condensation on the surface and contact with terminals due to cold will damage, stain or dirty the polarizers. After products are tested at low temperature they must be warmed up in a container before coming is contacting with room temperature air.
- ◆ Do not put or attach anything on EastRising display area to avoid leaving marks on.
- ◆ Do not touch the display with bare hands. This will stain the display area and degradate insulation between terminals (some cosmetics are determinated to the polarizers).
- ◆ As glass is fragile. It tends to become or chipped during handling especially on the edges. Please avoid dropping.

7.2 Installing LCD Modules

- ◆ Cover the surface with a transparent protective plate to protect the polarizer and LC cell.
- ◆ When assembling the LCM into other equipment, the spacer to the bit between the LCM and the fitting plate should have enough height to avoid causing stress to the module surface, refer to the individual specifications for measurements. The measurement tolerance should be ± 0.1 mm.

7.3 Precaution for Handling LCD Modules

Since EastRising LCM has been assembled and adjusted with a high degree of precision; avoid applying excessive shocks to the module or making any alterations or modifications to it.

- ◆ Do not alter, modify or change the shape of the tab on the metal frame.
- ◆ Do not make extra holes on the printed circuit board, modify its shape or change the positions of components to be attached.
- ◆ Do not damage or modify the pattern writing on the printed circuit board.
- ◆ Absolutely do not modify the zebra rubber strip (conductive rubber) or heat seal connector.
- ◆ Except for soldering the interface, do not make any alterations or modifications with a soldering iron.
- ◆ Do not drop, bend or twist EastRising LCM.

7.4 Electro-Static Discharge Control

Since this module uses a CMOS LSI, the same careful attention should be paid to electrostatic discharge as for an ordinary CMOS IC.

- ◆ Make certain that you are grounded when handling LCM.
- ◆ Before remove LCM from its packing case or incorporating it into a set, be sure the module and your body have the same electric potential.
- ◆ When soldering the terminal of LCM, make certain the AC power source for the soldering iron does not leak.
- ◆ When using an electric screwdriver to attach LCM, the screwdriver should be of ground potentiality to minimize as much as possible any transmission of electromagnetic waves produced sparks coming from the commutator of the motor.
- ◆ As far as possible make the electric potential of your work clothes and that of the work bench the ground potential.
- ◆ To reduce the generation of static electricity be careful that the air in the work is not too dried. A relative humidity of 50%-60% is recommended.

7.5 Precaution for Soldering to EastRising LCM

- ◆ Observe the following when soldering lead wire, connector cable and etc. to the LCM.
 - Soldering iron temperature : $280^{\circ}\text{C}\pm 10^{\circ}\text{C}$
 - Soldering time: 3-4 sec.
 - Solder: eutectic solder.

If soldering flux is used, be sure to remove any remaining flux after finishing to soldering operation. (This does not apply in the case of a non-halogen type of flux.) It is recommended that you protect the LCD surface with a cover during soldering to prevent any damage due to flux spatters.

- ◆ When soldering the electroluminescent panel and PC board, the panel and board should not be detached more than three times. This maximum number is determined by the temperature and time conditions mentioned above, though there may be some variance depending on the temperature of the soldering iron.
- ◆ When remove the electroluminescent panel from the PC board, be sure the solder has completely melted, the soldered pad on the PCs board could be damaged.

7.6 Precaution for Operation

- ◆ Driving the EastRising LCD in the voltage above the limit shortens its life.
- ◆ Response time is greatly delayed at temperature below the operating temperature range. However, this does not mean the LCD will be out of the order. It will recover when it returns to the specified temperature range.
- ◆ If EastRising display area is pushed hard during operation, the display will become abnormal. However, it will return to normal if it is turned off and then back on.
- ◆ Condensation on terminals can cause an electrochemical reaction disrupting the terminal circuit. Therefore, it must be used under the relative condition of 40°C , 50% RH.
- ◆ When turning the power on, input each signal after the positive/negative voltage becomes stable.

7.7 Limited Warranty

Unless agreed between EastRising and customer, EastRising will replace or repair any of its LCD modules which are found to be functionally defective when inspected in accordance with EastRising LCD acceptance standards (copies available upon request) for a period of one year from date of shipments. Cosmetic/visual defects must be returned to EastRising within 90 days of shipment. Confirmation of such date shall be based on freight documents. The warranty liability of EastRising limited to repair and/or replacement on the terms set forth above. EastRising will not be responsible for any subsequent or consequential events.

7.8 Return Policy

No warranty can be granted if the precautions stated above have been disregarded. The typical examples of violations are:

- Broken LCD glass.
- PCB eyelet damaged or modified.
- PCB conductors damaged.
- Circuit modified in any way, including addition of components.
- PCB tampered with by grinding, engraving or painting varnish.
- Soldering to or modifying the bezel in any manner.

Module repairs will be invoiced to the customer upon mutual agreement. Modules must be returned with sufficient description of the failures or defects. Any connectors or cable installed by the customer must be removed completely without damaging the PCB eyelet's, conductors and terminals.

8. IMAGE STICKING

8.1 What is Image Sticking?

If you remain a fixed image on LCD Display for a long period of time, you may experience a phenomenon called Image Sticking. Image Sticking - sometimes also called "image retention" or "ghosting" - is a phenomenon where a faint outline of a previously displayed image remains visible on the screen when the image is changed. It can occur at variable levels of intensity depending on the specific image makeup, as well as the amount of time the core image elements are allowed to remain unchanged on the screen. In POS applications, for example, a button menu which remains fixed, or in which the "frame" elements (core image) remain fixed and the buttons may change, may be susceptible to image sticking. It is important to note that if the screen is used exclusively for this application, the user may never notice this phenomenon since the screen never displays other content. It is only when an image other than the "retained" image is shown on the screen that this issue becomes evident. Image sticking is different than the "burn-in" effect commonly associated with phosphor based devices.

8.2 What causes Image Sticking?

Image sticking is an intrinsic behavior of LCD displays due to the susceptibility to polarization of the interior materials (liquid crystals) when used under static, charged conditions (continuously displaying the same image). The individual liquid crystals in an LCD panel have unique electrical properties. Displaying a fixed pattern - such as the POS menu described above - over prolonged periods can cause a parasitic charge build-up (polarization) within the liquid crystals which affects the crystals' optical properties and ultimately prevents the liquid crystal from returning to its normal, relaxed state when the pattern is finally changed. This effect takes place at a cellular level within the LCD, and the effect can cause charged crystal alignment at the bottom or top of a crystal cell in the "z" axis, or even crystal migration to the edges of a cell, again based on their polarity. These conditions can cause image sticking over an entire area, or at boundaries of distinct color change respectively. In either case, when the liquid crystals in the pixels and sub-pixels utilized to display the static image are polarized such that they can not return fully to their "relaxed" state upon deactivation, the result is a faint, visible, retained image on the panel upon presentation of a new, different image. The actual rate of image retention depends on variation factors such as the specific image, how long it is displayed unchanged, the temperature within the panel and even the specific panel brand due to manufacturing differences amongst panel manufacturers.

8.3 How to Avoid Image Sticking?

- Try not to operate the LCD with a “fixed” image on the screen for more than 2 hours.
- If you are operating the monitor in an elevated temperature environment and with a displayed image which is contrary to the recommendations in “For Software Developers” below, image stick can occur in as little as 30 minutes. Adjust your screen saver settings accordingly.
- Power down the unit during prolonged periods of inactivity such as the hours a store is closed or a shift during which the piece of equipment isn’ t used.
- Use a screensaver with a black or medium gray background that is automatically set to come on if the device is inactive for more than 5-10 minutes.
- Avoid placing the monitor in poorly ventilated areas or in areas that will create excess heat around the monitor for software developers.
- In defining the icons, buttons, or windows in the screen, try to utilize block patterns instead of distinct lines as borders for dividing the display into distinct areas.
- If it is necessary to display a static image, try to use colors that are symmetric to the middle grey level at the boundary of two different colors, and slightly shift the borders line once in a while.
- Try to utilize medium gray hues for those areas that will have prolonged display times or remain static as other menu elements change.

8.4 How to Fix the Image Sticking?

Unlike the usually irreversible “burn-in” effects commonly associated with direct view phosphor display devices such as CRTs, an image retained on an LCD display can be reversed – often to a point of total invisibility. However, the severity of the underlying causes (as described above) of the image retained on a specific display, as well as the variation factors (see “For Software Developers” above) under which the retained image was created, will dictate the final level of retention reversal. One way to erase a retained image on a panel is to run the screen (monitor “on”) in an “all black” pattern for 4-6 hours. It is also helpful to do this in an elevated temperature environment of approximately 35° to 50°C. Again, utilizing a dynamic screen saver with an all black background during prolonged idle display periods is a good way to avoid image retention issues.

8.5 Is Image Sticking Covered by EastRising RMA Warranty?

Image sticking is a phenomenon inherent to LCD Display technology itself, and as such, the occurrence of this “ghosting” effect is considered normal operation by the manufacturers of the LCD display modules which are integrated into today’ s monitor solutions. EastRising does not warrant any display against the occurrence of image sticking. We strongly advise that you follow the operating recommendations listed above to avoid the occurrence of this phenomenon.

That's the end of the datasheet.