

Self-Capacitive Touch Panel Controller

INTRODUCTION

The FT6236U are single-chip capacitive touch panel controller IC with a built-in 16 bit enhanced Micro-controller unit (MCU). They adopt the self-capacitance technology, which supports single point and gesture touch or two points. In conjunction with a self-capacitive touch panel, The FT6236U implement the user-friendly input function and are widely used in various portable devices, such as smart phones, MIDs and GPS.

FEATURES

- Self-Capacitive Sensing Techniques support single point touch and gesture or two point touch
- Absolute X and Y coordinates or gesture
- 1 point and gestures
- High immunity to RF and power Interferences
- Auto-calibration: Insensitive to Capacitance and Environmental Variations
- Built-in Enhanced MCU
- FT6236U supports up to 28 channels of sensors /drivers
- Report Rate: Up to 100Hz
- Support Interfaces :I2C
- Support single film material TP and triangle pattern without additional shield
- Internal accuracy ADC and smooth filters
- Support 2.8V to 3.6V Operating Voltage
- Support independent IOVCC
- Built-in LDO for Digital Circuits
- High efficient power management with 3 Operating Modes
 - Active Mode
 - Monitor Mode
 - Hibernation Mode
- Operating Temperature Range: -40°C to +85°C
- ESD:HBM \geq 7500V,MM \geq 500V

TABLE OF CONTENTS

INTRODUCTION	I
FEATURES.....	I
1 OVERVIEW	1
1.1 TYPICAL APPLICATIONS	1
2 FUNCTIONAL DESCRIPTION.....	1
2.1 ARCHITECTURAL OVERVIEW.....	1
2.2 MCU.....	2
2.3 OPERATION MODES.....	2
2.4 SERIAL INTERFACE.....	3
2.4.1 I2C.....	3
3 ELECTRICAL SPECIFICATIONS.....	4
3.1 ABSOLUTE MAXIMUM RATINGS.....	4
3.2 DC CHARACTERISTICS	4
*1: REPORT RATE: 75HZ @ 4"TP	5
3.3 AC CHARACTERISTICS	5
3.4 I/O PORTS CIRCUITS.....	6
3.5 POWER ON/RESET/WAKE SEQUENCE.....	6
4 PIN CONFIGURATIONS	8
5 PACKAGE INFORMATION	10
5.1 PACKAGE INFORMATION OF QFN-5X5-40L PACKAGE	10

1 OVERVIEW

1.1 Typical Applications

FT6236U accommodate a wide range of applications with a set of buttons up to a 2D touch sensing device, their typical applications are listed below.

- Mobile phones, smart phones
- GPS
- Game consoles
- POS (Point of Sales) devices
- Portable MP3 and MP4 media players
- Digital cameras
- MIDs

FT6236U series ICs support up to 4 inch Touch Panel; users may find out their target IC from the specs listed in the following table,

Model Name	Panel	Package			Touch Panel Size
	Channel	Type	Pin	Size	
FT6236U	28	QFN5*5	40	0.6-P0.4	≤4.0 inch

2 FUNCTIONAL DESCRIPTION

2.1 Architectural Overview

Figure2-1 shows the overall architecture for the FT6236U.

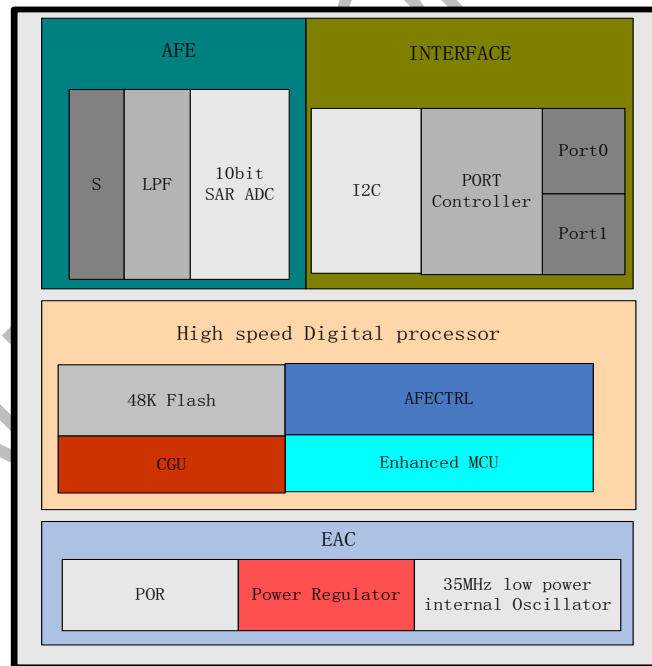

Figure 2-1 FT6236U System Architecture Diagram

The FT6236U is comprised of five main functional parts listed below,

- Touch Panel Interface Circuits

The main function for the AFE and AFE controller is to interface with the touch panel. It scans the panel by sending AC signals to the panel and processes the received signals from the panel. So it supports both driver and Sensor functions. Key parameters to configure this circuit can be sent via serial interfaces.

- Enhanced MCU

For the Enhanced MCU, larger program and data memories are supported. Furthermore, A Flash ROM is implemented to store

THIS DOCUMENT CONTAINS INFORMATION PROPRIETARY TO FOCALTECH SYSTEMS CO.,LTD., AND MAY NOT BE REPRODUCED, DISCLOSED OR USED IN WHOLE OR PART WITHOUT THE EXPRESS WRITTEN PERMISSION OF FOCALTECH SYSTEMS CO.,LTD.

programs and some key parameters.

Complex signal Processing algorithms are implemented by MCU to detect the touches reliably and efficiently.

Communication protocol software is also implemented on this MCU to exchange data and control information with the host processor.

- External Interface
 - I2C: an interface for data exchange with host
 - INT: an interrupt signal to inform the host processor that touch data is ready for read
 - RSTN: an external low signal reset the chip.
- A watch dog timer is implemented to ensure the robustness of the chip.
- A voltage regulator to generate 1.5V for digital circuits from the input VDDA supply.

2.2 MCU

This section describes some critical features and operations supported by the Enhanced MCU.

Figure 2-2 shows the overall structure of the MCU block. In addition to the Enhanced MCU core, we have added the following circuits,

- Memory:48KB Flash
- Data Memory: 5KB SRAM
- Timer: A number of timers are available to generate different clocks
- Master Clock:18MHz from a 36MHz RC Oscillator
- Clock Manager: To control various clocks under different operation conditions of the system

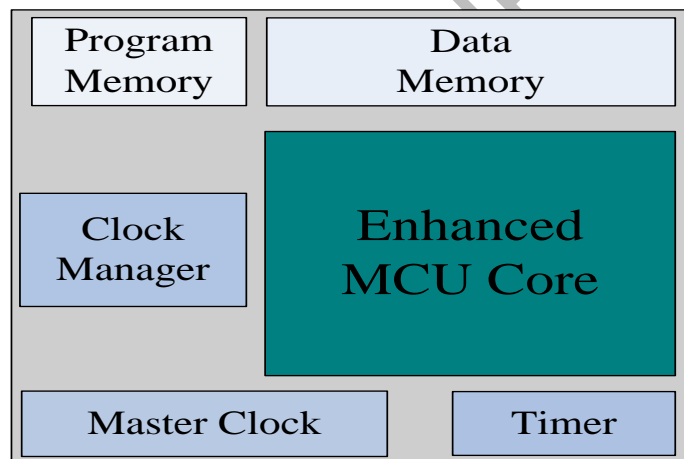

Figure 2-2 MCU Block Diagram

2.3 Operation Modes

FT6236U operates in the following three modes:

- Active Mode

In this mode, FT6236U actively scans the panel. The default scan rate is 60 frames per second. The host processor can configure FT6236U to speed up or to slow down.

- Monitor Mode

In this mode, FT6236U scans the panel at a reduced speed. The default scan rate is 25 frames per second and the host processor can increase or decrease this rate. When in this mode, most algorithms are stopped. A simpler algorithm is being executed to determine if there is a touch or not. When a touch is detected, FT6236U shall enter the Active mode immediately to acquire the touch information quickly. During this mode, the serial port is closed and no data shall be transferred with the host processor

- Hibernation Mode

In this mode, the chip is set in a power down mode. It shall respond to the “RESET” or “Wakeup” signal from the host processor. The chip therefore consumes very little current, which help prolong the standby time for the portable devices.

Host Interface Figure 2-3 shows the interface between a host processor and FT6236U. This interface consists of the following three sets of signals:

- Serial Interface

THIS DOCUMENT CONTAINS INFORMATION PROPRIETARY TO FOCALTECH SYSTEMS CO.,LTD., AND MAY NOT BE REPRODUCED, DISCLOSED OR USED IN WHOLE OR PART WITHOUT THE EXPRESS WRITTEN PERMISSION OF FOCALTECH SYSTEMS CO.,LTD.

- Interrupt from FT6236U to the Host
- Reset Signal from the Host to FT6236U

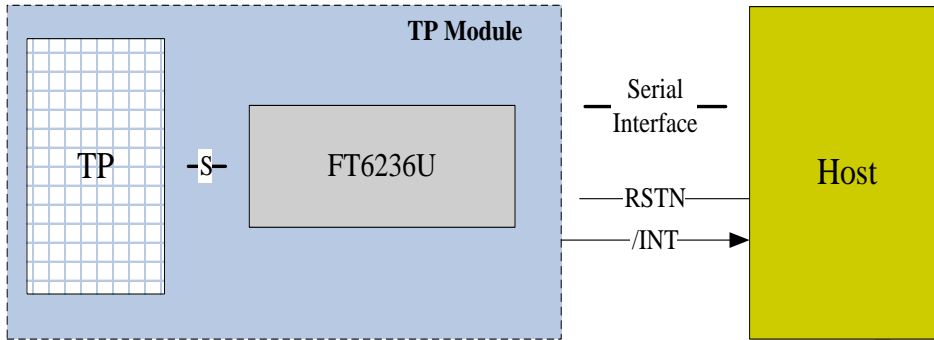

Figure 2-3 Host Interface Diagram

The serial interface of FT6236U is I2C. The details of this interface are described in detail in Section 2.4. The interrupt signal (/INT) is used for FT6236U to inform the host that data are ready for the host to receive. The RSTN signal is used for the host to reset FT6236U. After resetting, FT6236U shall enter the Active mode.

2.4 Serial Interface

FT6236U supports the I2C interfaces, which can be used by a host processor or other devices.

2.4.1 I2C

The I2C is always configured in the Slave mode. The data transfer format is shown in Figure 2-4.

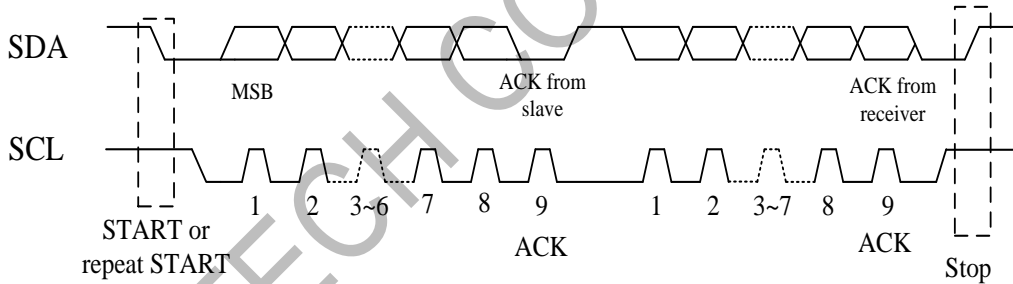

Figure 2-4 I2C Serial Data Transfer Format

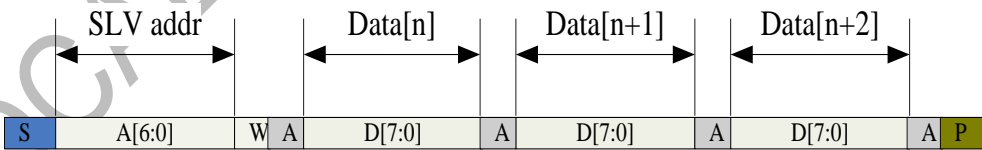

Figure 2-5 I2C master write, slave read

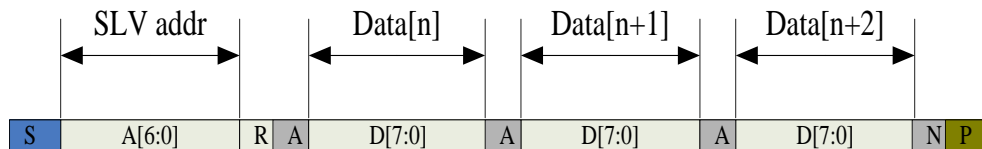

Figure 2-6 I2C master read, slave write

Table 2-1 lists the meanings of the mnemonics used in the above figures.

Table 2-1 Mnemonics Description

Mnemonics	Description
S	I2C Start or I2C Restart
A[6:0]	Slave address
R/W	READ/WRITE bit, '1' for read, '0' for write
A(N)	ACK(NACK)
P	STOP: the indication of the end of a packet (if this bit is missing, S will indicate the end of the current packet and the beginning of the next packet)

I2C Interface Timing Characteristics is shown in Table 2-2.

Table 2-2 I2C Timing Characteristics

Parameter	Min	Max	Unit
SCL frequency	10	400	KHz
Bus free time between a STOP and START condition	4.7	\	us
Hold time (repeated) START condition	4.0	\	us
Data setup time	250	\	ns
Setup time for a repeated START condition	4.7	\	us
Setup Time for STOP condition	4.0	\	us

3 ELECTRICAL SPECIFICATIONS

3.1 Absolute Maximum Ratings

Table 3-1 Absolute Maximum Ratings

Item	Symbol	Value	Unit	Note
Power Supply Voltage	VDDA - VSSA	-0.3 ~ +3.6	V	1, 2
Power Supply Voltage2	VDD3 - VSS	-0.3 ~ +3.6	V	1, 3
I/O Digital Voltage	IOVCC	1.8~3.6	V	1
Operating Temperature	Topr	-40 ~ +85	°C	1
Storage Temperature	Tstg	-55 ~ +150	°C	1

Notes

1. If used beyond the absolute maximum ratings, FT6236U may be permanently damaged. It is strongly recommended that the device be used within the electrical characteristics in normal operations. If exposed to the condition not within the electrical characteristics, it may affect the reliability of the device.
2. Make sure VDDA (high) \geq VSSA (low).
3. Make sure VDD(high) \geq VSS(low).

3.2 DC Characteristics

Table 3-2 DC Characteristics (VDDA=2.8~3.6V, Ta=-40~85°C)

Item	Symbol	Test Condition	Min.	Typ.	Max.	Unit	Note
Input high-level voltage	VIH		0.7 x IOVCC	-	IOVCC	V	
Input low -level voltage	VIL		-0.3	-	0.3 x IOVCC	V	
Output high -level voltage	VOH	IOH=-0.1mA	0.7 x IOVCC	-	-	V	
Output low -level voltage	VOL	IOH=0.1mA	-	-	0.3 x IOVCC	V	
I/O leakage current	ILI	Vin=0~VDDA	-1	-	1	μA	

THIS DOCUMENT CONTAINS INFORMATION PROPRIETARY TO FOCALTECH SYSTEMS CO.,LTD., AND MAY NOT BE REPRODUCED, DISCLOSED OR USED IN WHOLE OR PART WITHOUT THE EXPRESS WRITTEN PERMISSION OF FOCALTECH SYSTEMS CO.,LTD.

Current consumption (Normal operation mode)	Iopr	VDDA =VDD3= 2.8V Ta=25°C MCLK=18MHz	-	4.32 ^{*1}	-	mA	
Current consumption (Monitor mode)	Imon	VDDA =VDD3= 2.8V Ta=25°C MCLK=18MHz	-	220 ^{*2}	-	mA	
Current consumption (Sleep mode)	Islp	VDDA =VDD3= 2.8V Ta=25°C	-	55	-	uA	
Step-up output voltage	VDD5	VDDA = VDD3=2.8V	-	5	-	V	
Power Supply voltage	VDDA VDD3		2.8	-	3.6	V	

*1: Report Rate: 75Hz @ 4"TP

*2: Report Rate: 25Hz @ 4"TP

3.3 AC Characteristics

Table 3-3 AC Characteristics of Oscillators

Item	Symbol	Test Condition	Min	Typ.	Max	Unit	Note
OSC clock 1	fosc1	VDDA= 2.8V; Ta=25°C	34.64	36	36.36	MHz	

Table 3-4 AC Characteristics of sensor

Item	Symbol	Test Condition	Min	Typ.	Max	Unit	Note
Sensor acceptable clock	ftx	VDDA= 2.8V; Ta=25°C	0	100	300	KHz	
Sensor output rise time	Ttxr	VDDA= 2.8V; Ta=25°C	-	100	-	nS	
Sensor output fall time	Ttxf	VDDA= 2.8V; Ta=25°C	-	80	-	nS	
Sensor input voltage	Trxi	VDDA= 2.8V; Ta=25°C	-	5	-	V	

3.4 I/O Ports Circuits

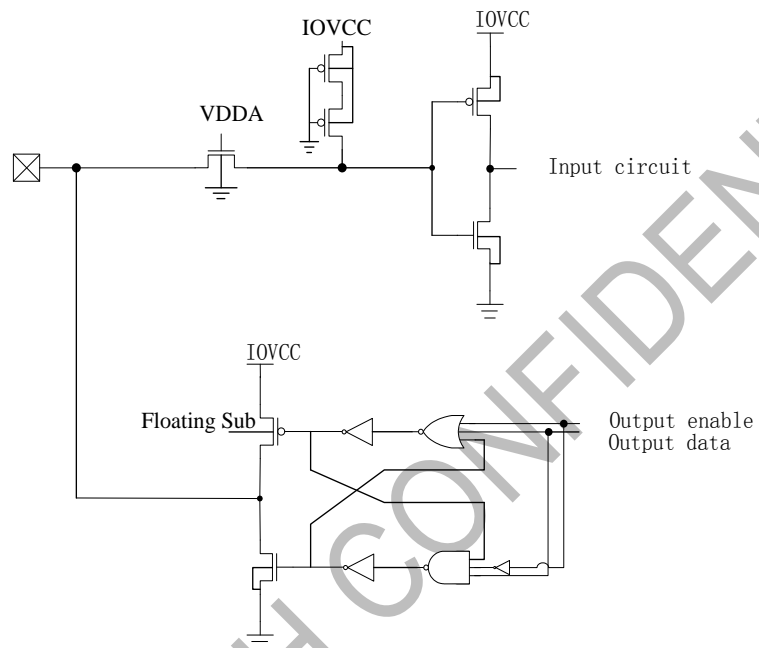

Figure 3-1 Digital In/Out Port Circuit

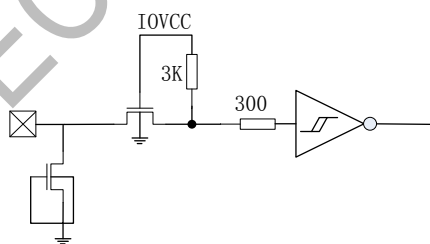

Figure 3-2 Reset Input Port Circuits

3.5 POWER ON/Reset/Wake Sequence

The GPIO such as INT and I2C are advised to be low before powering on. Reset should be pulled down to be low before powering on. INT signal will be sent to the host after initializing all parameters and then start to report points to the host. If Power is down, the voltage of supply must be below 0.3V and Trst is more than 5ms.

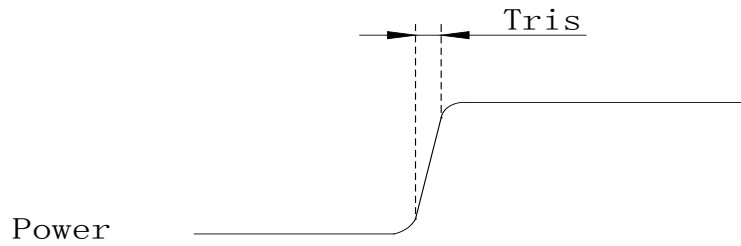

Figure 3-7 Power on time

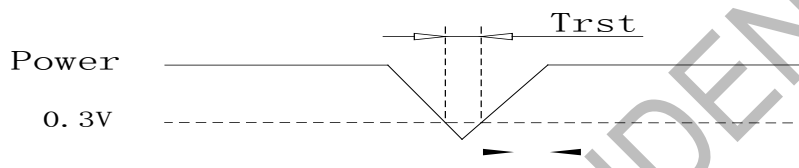

Figure 3-8 Power Cycle requirement

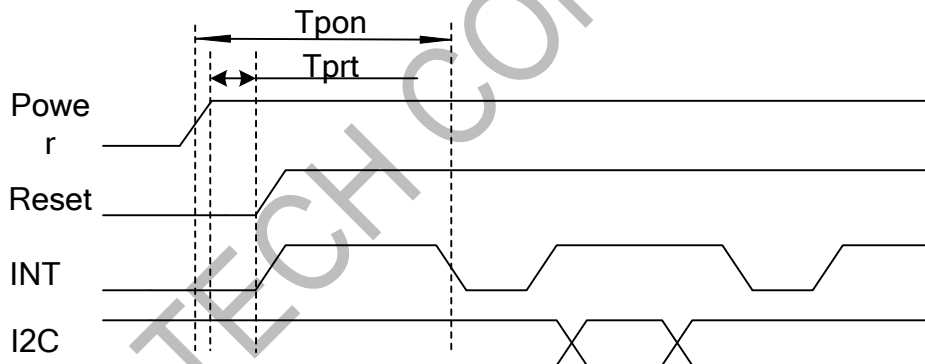

Figure 3-9 Power on Sequence

Reset time must be enough to guarantee reliable reset, the time of starting to report point after resetting approach to the time of starting to report point after powering on.

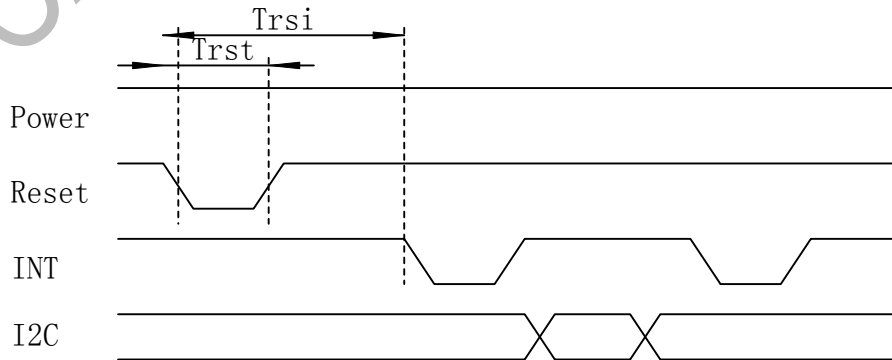

Figure 3-10 Reset Sequence

Table 3-5 Power on/Reset/Wake Sequence Parameters

THIS DOCUMENT CONTAINS INFORMATION PROPRIETARY TO FOCALTECH SYSTEMS CO.,LTD., AND MAY NOT BE REPRODUCED, DISCLOSED OR USED IN WHOLE OR PART WITHOUT THE EXPRESS WRITTEN PERMISSION OF FOCALTECH SYSTEMS CO.,LTD.

Parameter	Description	Min	Max	Units
Tris	Rise time from 0.1VDD to 0.9VDD	-	3	ms
Tpon	Time of starting to report point after powering on	300	-	ms
Tprt	Time of being low after powering on	1	-	ms
Trsi	Time of starting to report point after resetting	300	-	ms
Trst	Reset time	5	-	ms

4 PIN CONFIGURATIONS

Table 4-1 Pin Definition of FT6236U

Name	Pin No.	Type	Description
EF	1	PWR	Generated internal reference voltage. A 1 μ F ceramic capacitor to ground is required.
S1	2	I/O	Capacitance sensor /driver channel
S2	3	I/O	Capacitance sensor /driver channel
S3	4	I/O	Capacitance sensor /driver channel
S4	5	I/O	Capacitance sensor /driver channel
S5	6	I/O	Capacitance sensor /driver channel
S6	7	I/O	Capacitance sensor /driver channel
S7	8	I/O	Capacitance sensor /driver channel
S8	9	I/O	Capacitance sensor /driver channel
S9	10	I/O	Capacitance sensor /driver channel
S10	11	I/O	Capacitance sensor /driver channel
S11	12	I/O	Capacitance sensor /driver channel
S12	13	I/O	Capacitance sensor /driver channel
S13	14	I/O	Capacitance sensor /driver channel
S14	15	I/O	Capacitance sensor /driver channel
S15	16	I/O	Capacitance sensor /driver channel
S16	17	I/O	Capacitance sensor /driver channel
S17	18	I/O	Capacitance sensor /driver channel
S18	19	I/O	Capacitance sensor /driver channel
S19	20	I/O	Capacitance sensor /driver channel
S20	21	I/O	Capacitance sensor /driver channel
S21	22	I/O	Capacitance sensor /driver channel
S22	23	I/O	Capacitance sensor /driver channel
S23	24	I/O	Capacitance sensor /driver channel
S24	25	I/O	Capacitance sensor /driver channel
S25	26	I/O	Capacitance sensor /driver channel
S26	27	I/O	Capacitance sensor /driver channel
S27	28	I/O	Capacitance sensor /driver channel
S28	29	I/O	Capacitance sensor /driver channel
VDD5	30	PWR	High voltage power supply from the charge pump LDO generated internally. A 1 μ F ceramic to ground is required.
VSSA	31	GND	Analog ground

THIS DOCUMENT CONTAINS INFORMATION PROPRIETARY TO FOCALTECH SYSTEMS CO.,LTD., AND MAY NOT BE REPRODUCED, DISCLOSED OR USED IN WHOLE OR PART WITHOUT THE EXPRESS WRITTEN PERMISSION OF FOCALTECH SYSTEMS CO.,LTD.

VDDA	32	PWR	Analog power supply, A 1μF ceramic capacitor to ground is required.
VSS	33	GND	Analog ground
VDDD	34	PWR	Digital power supply. A 1μF ceramic capacitor to ground is required.
VSSD		GND	Analog ground
RSTN	36	I	External Reset, Low is active
IOVCC	37	PWR	I/O power supply
SCL	38	I/O	I2C clock input
SDA	39	I/O	I2C data input and output
INT	40	I/O	External interrupt to the host

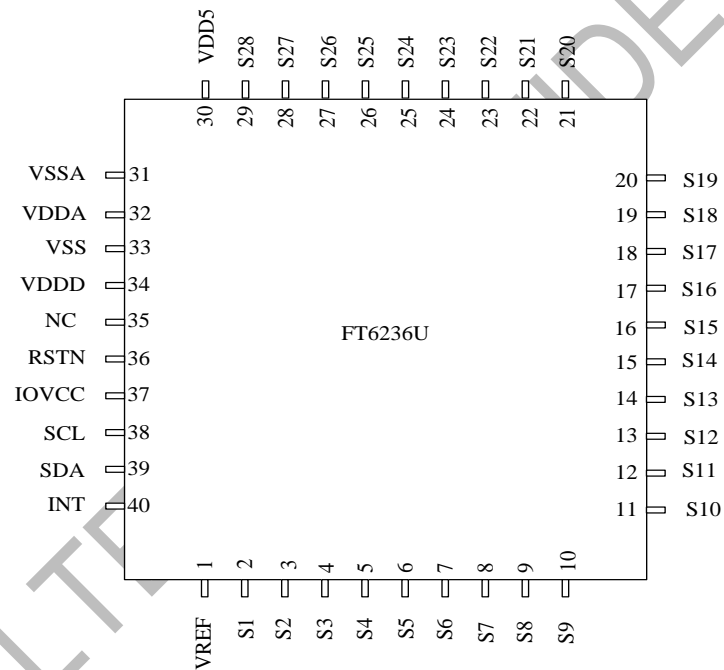

FT6236U Package Diagram

5 PACKAGE INFORMATION

5.1 Package Information of QFN-5x5-40L Package

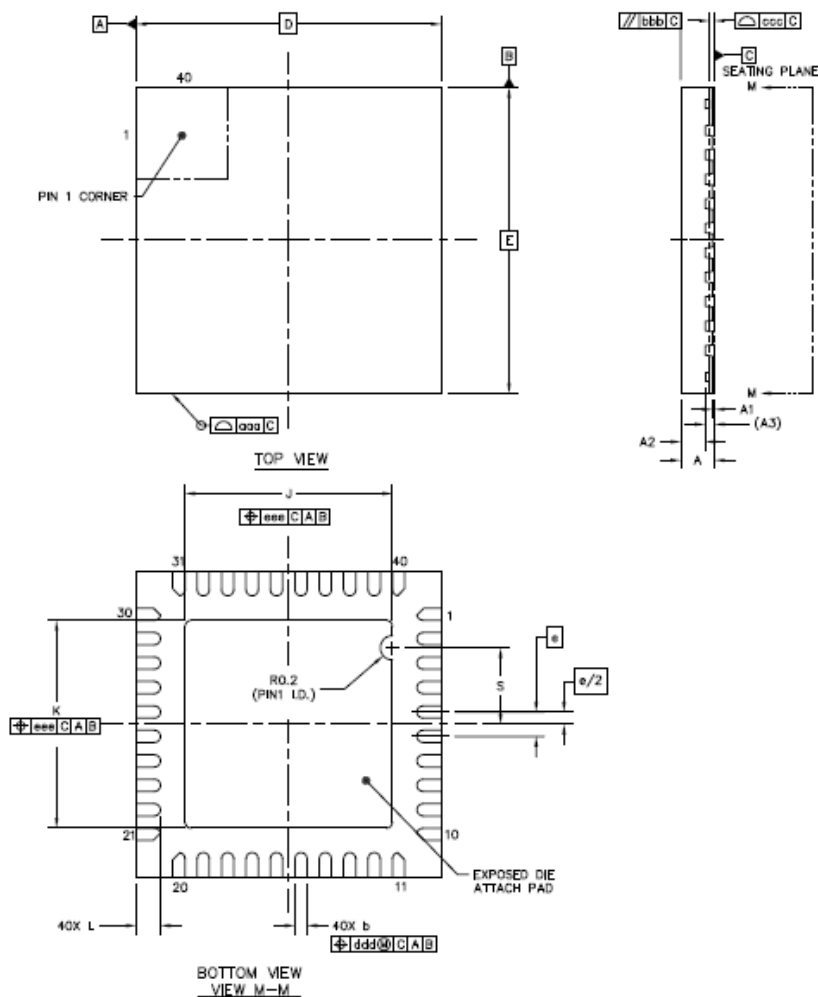

Item	Symbol	Millimeter		
		Min	Type	Max
Total Thickness	A	0.5	0.55	0.6
Stand Off	A1	0	0.035	0.05
Mold Thickness	A2	----	0.4	0.425
L/F Thickness	A3	0.152 REF		
Lead Width	b	0.15	0.20	0.25
Body Size	D	5 BSC		
	E	5 BSC		
Lead Pitch	e	0.4 BSC		
EP Size	J	3.3	3.4	3.5
	K	3.3	3.4	3.5
Lead Length	L	0.35	0.4	0.45
Package Edge Tolerance	aaa	0.1		
Mold Flatness	bbb	0.1		
Co Planarity	ccc	0.08		
Lead Offset	ddd	0.1		
Exposed Pad Offset	eee	0.1		

END OF DATASHEET

THIS DOCUMENT CONTAINS INFORMATION PROPRIETARY TO FOCALTECH SYSTEMS CO.,LTD., AND MAY NOT BE REPRODUCED, DISCLOSED OR USED IN WHOLE OR PART WITHOUT THE EXPRESS WRITTEN PERMISSION OF FOCALTECH SYSTEMS CO.,LTD.